

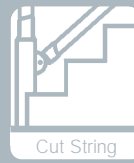

staircase configurations



The string is the side of the staircase on which the balustrade is assembled. A cut string has the upper edge cut away to the shape of each individual step, so that the profile can be seen from the side. A closed string has the face housed to accommodate the steps, so that their profile cannot be seen. For full fitting instructions for both closed and cut string, please see the installation instruction leaflet packed with the newel base connector MMBCS/G.

Straight with straight step

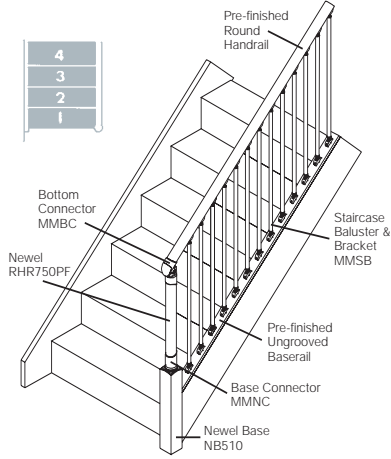

Straight with bullnose step

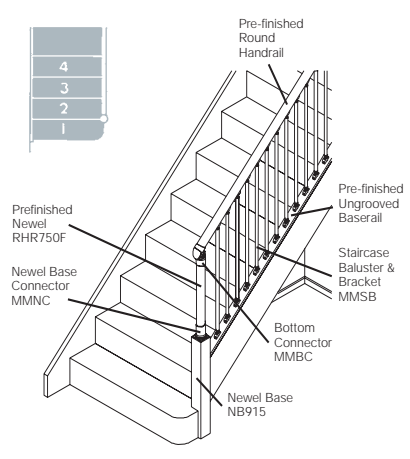

Dogleg with bullnose step

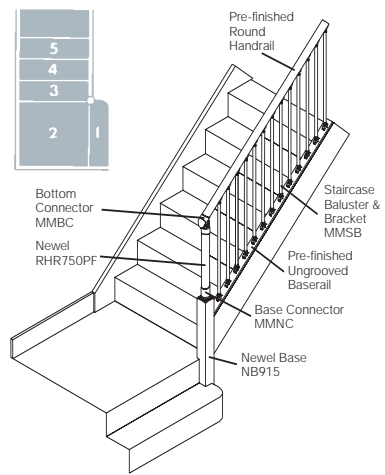

Top landing with 180° turn

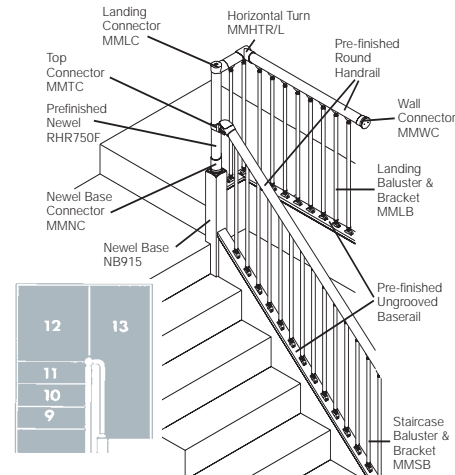

Top landing with 180° turn

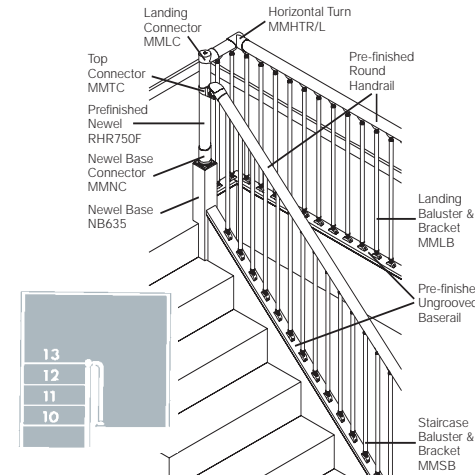

Staircase configurations with cut string option

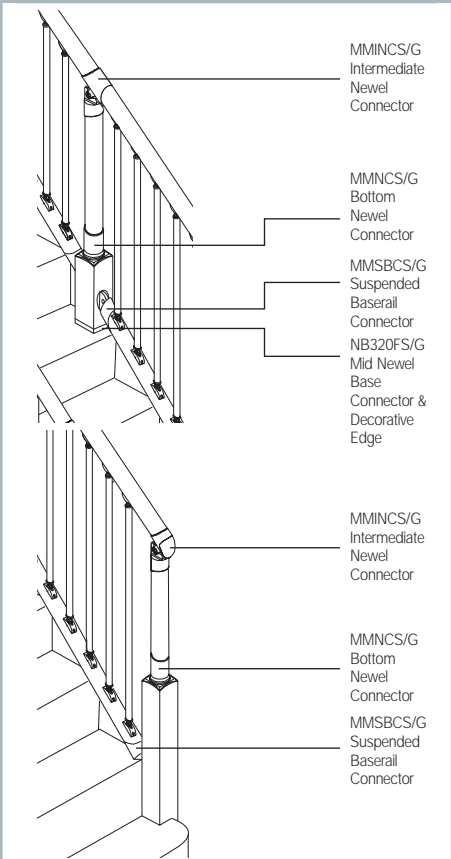

All of the closed string configurations can also be achieved on a cut string (as highlighted above). Installation instructions for both cut and closed string staircases are available with every newel base connector (MMBCS/G).

Winders

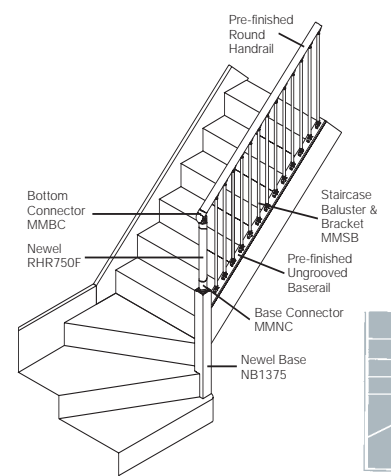

Dogleg with double bullnose and pulpit end

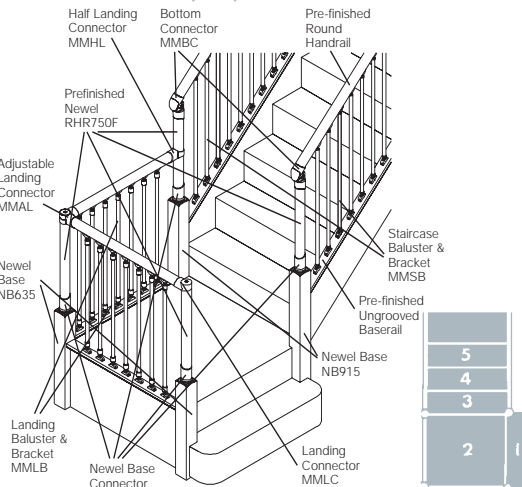

Quarter turn with landing

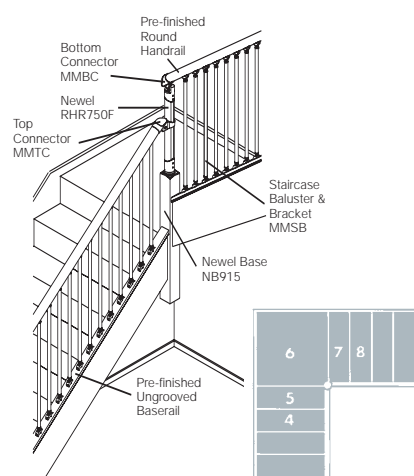

Top landing with 180° turn

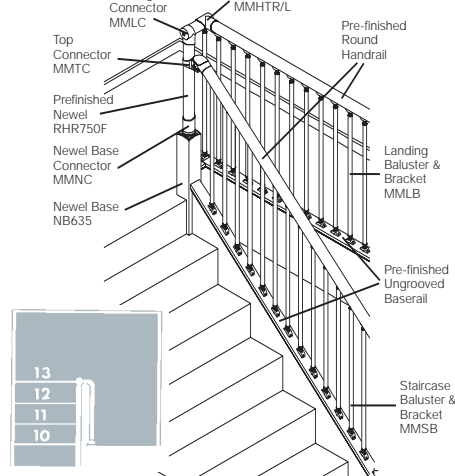

Top landing, 180° turn with winders

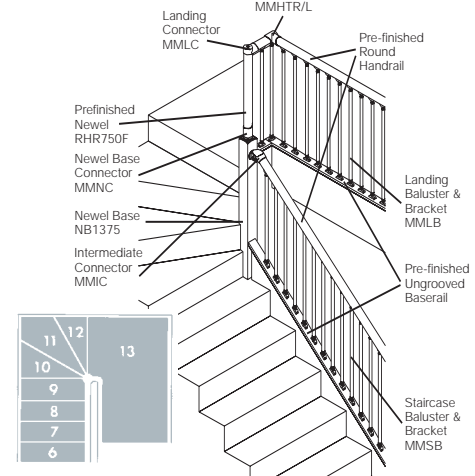

Quarter turn with 3 winders

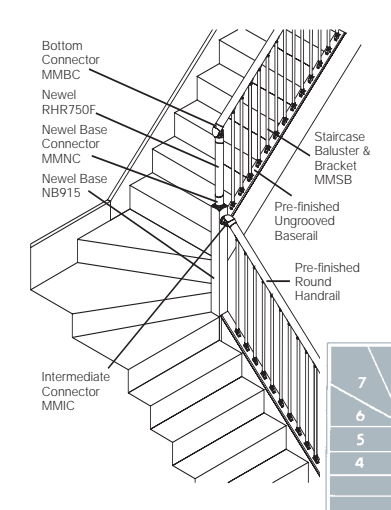

Half turn with extended landing

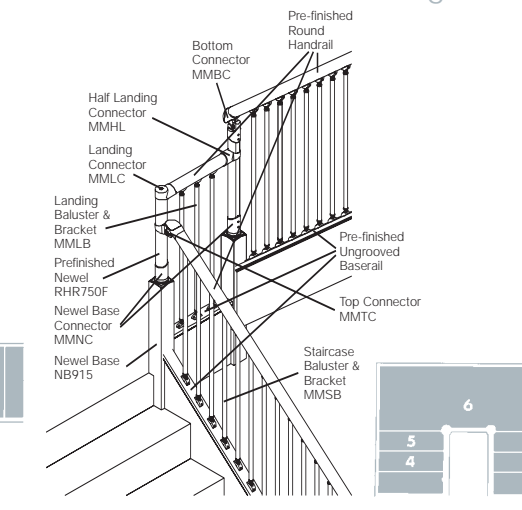

Top landing with 90° turn

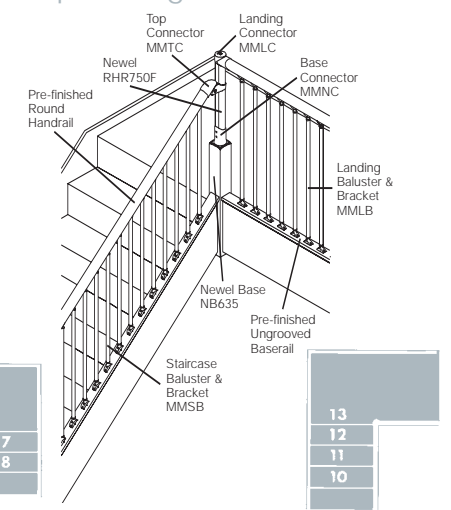

90° turn with straight rail (with newels)

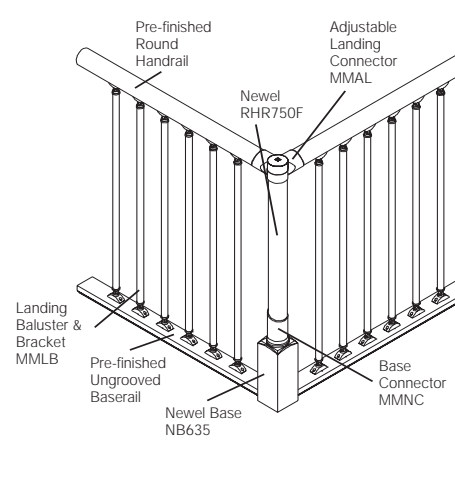

Continuous rail over newel

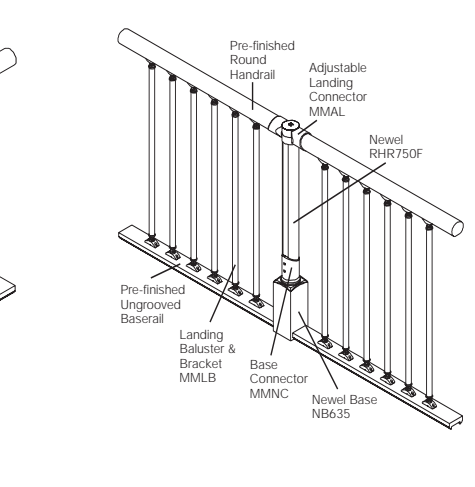

Landing or horizontal balustrading only

